

Customized solutions for moisture measurement in bulk solids

The right moisture sensor for every application

Moisture measuring technology



Endress+Hauser – Your partner for moisture measuring technology



Endress+Hauser is a leading international provider of measuring devices, services and solutions for industrial process engineering.

Professional support is guaranteed worldwide through its own Sales Centers and a network of partners. With product centers in twelve countries, Endress+Hauser is fast and flexible in meeting the needs of its customers. A holding company in Reinach/Switzerland manages and coordinates the company group. As a successful, family-run business, Endress+Hauser plans to remain an independent, unaffiliated company into the future.

Endress+Hauser supplies sensors, devices, systems and services for level, flow, pressure, temperature and moisture measurement, as well as analysis and measured value recording. The company supports its customers with services and solutions in the area of automation engineering, logistics and IT. The products set standards in terms of quality and technology.

Customers are primarily from the chemical/petrochemical, food and beverage, water/wastewater, life science, oil and gas, energy and power plant, renewable energies, metal and primaries, paper and pulp and shipbuilding industries. With support from Endress+Hauser, they are able to implement reliable, safe, efficient and environmentally friendly process-engineering procedures.

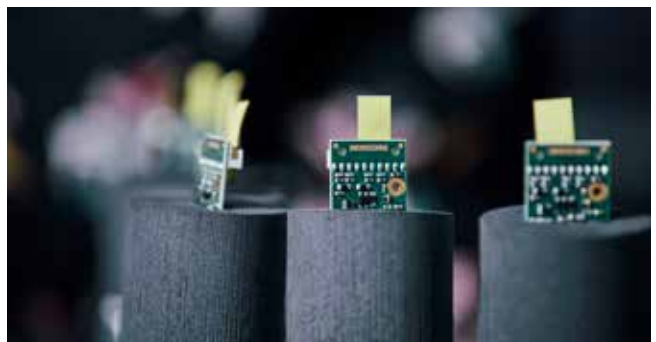
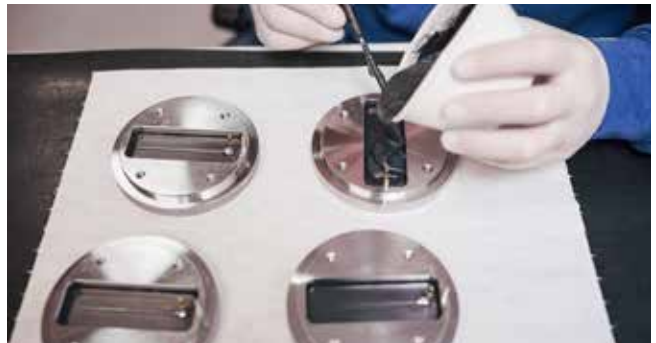

For further information on Endress+Hauser, see:
www.endress.com

Our focus industries

As a successful, family-run business in the area of laboratory and process automation, we strive to help our customers improve their products and increase the efficiency of their production. When it comes to moisture measurement in bulk solids, we focus on four specific industries to support our customers' processes and to offer them tailored products, services and solutions. In addition, we provide a comprehensive range of instruments covering all measurement methods as well as a product portfolio based on more than 60 years of experience.

Foods



Primaries



Energy



Water/wastewater





Solitrend sensors as "moisture tomographs"

The guided radar wave (TDR measuring principle) propagates at approximately the speed of light. The sensor measures the material on a slice-by-slice, layer for layer basis transverse to the sensor surface, as is familiar from a computer tomograph, for example.

This method results in a sensor with an exactly defined measurement field, which can measure without errors even in the event of fluctuating fines or varying grain size. By measuring transverse to the sensor surface, the mechanical condition of the sensor surface does not represent a disturbance variable, i.e. the recurrent and unavoidable wear of the sensor surface does not falsify the measured value.

The defined measurement field also enables accurate measurement for applications in which the material coverage is too low or fluctuates. This results in a high degree of flexibility in terms of mechanical integration in the application.

The sensor portfolio allows you to choose a suitable sensor design, enabling you to find the ideal solution for your application, always taking into account the framework conditions, such as moisture range, electrical conductivity, wear and mechanical installation.

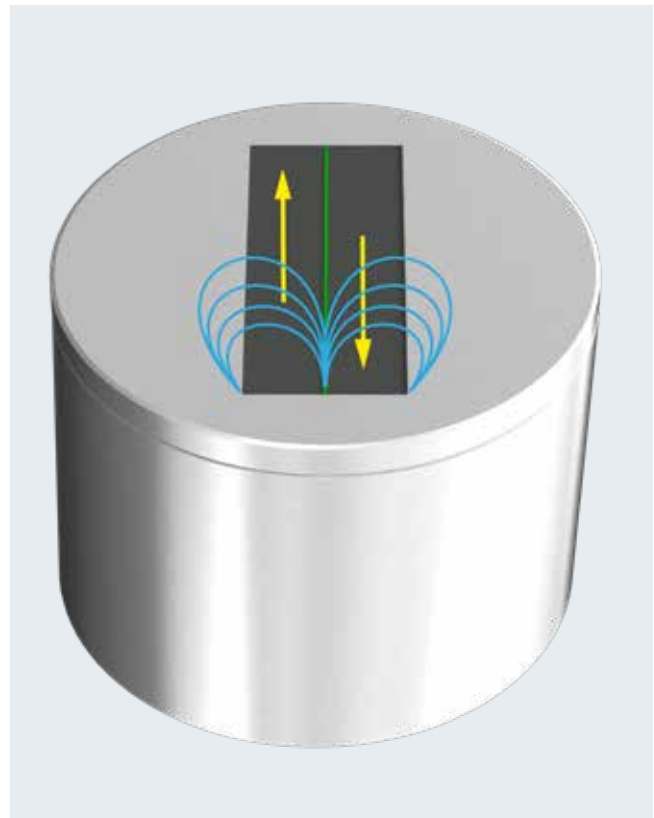

Solitrend sensors optimize your process moisture measurement

Increase your plant safety and save time and resources through innovative sensor technologies

All materials contain a certain amount of water. We are introducing a new generation of moisture measuring technology with our Solitrend sensors. The moisture content not only determines the quality of products, but also their shelf life and, due to the weight, their price. Legal requirements lay down the framework. Process moisture sensors allow you to determine the water content in your materials thus increasing the reliability and efficiency of your systems.







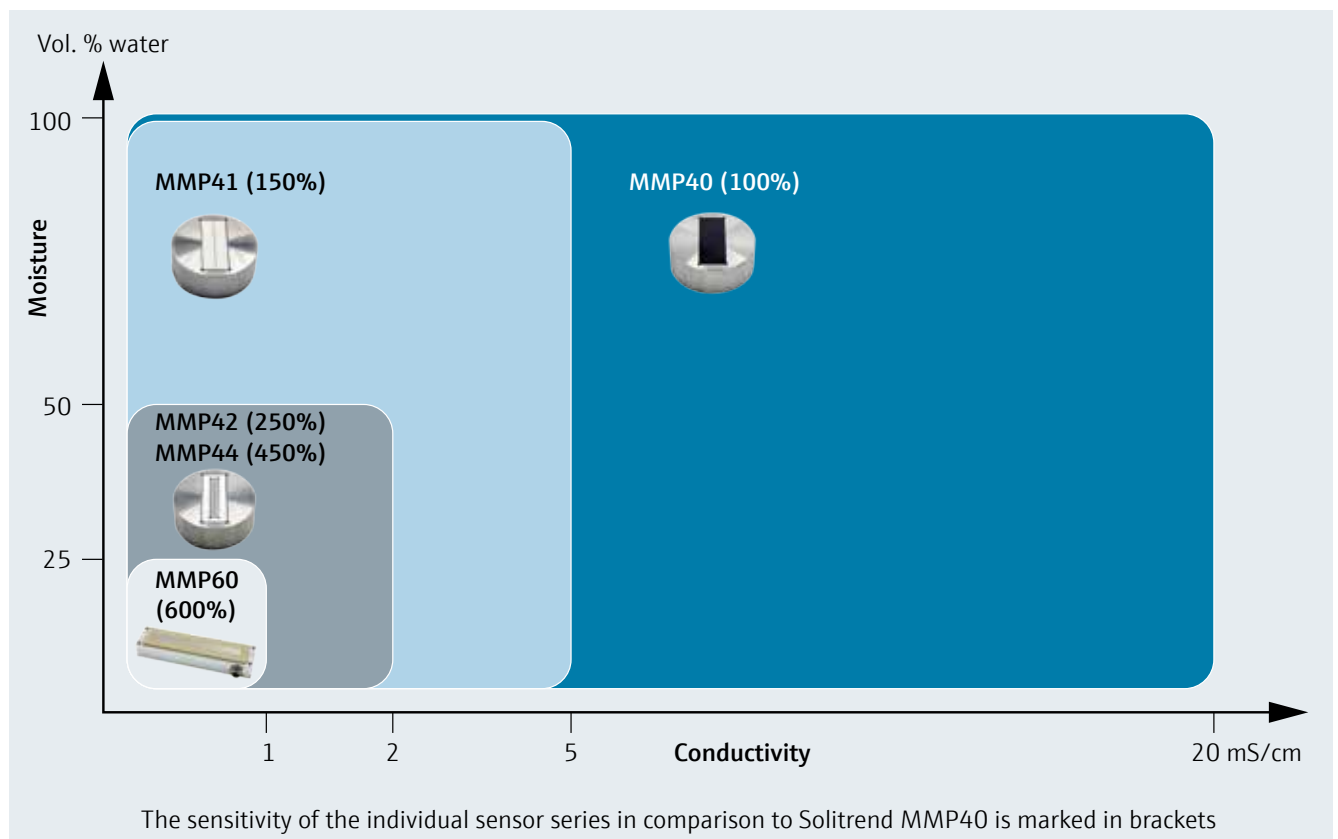

Solitrend sensor applications

Depending on the group, the sensors differ in resolution and measuring range. The higher the conductivity range of a sensor, the lower the resolution or performance characteristics.

Use the following diagram to help you choose your sensor. The application team would also be pleased to provide assistance.



State-of-the-art sensor technology for optimal measurement results

Process connection/sensor type	Solitrend MMP40	Solitrend MMP41	Solitrend MMP42
Applications	0 to 100% vol. water content No to high electrical conductivity (0 to 20 mS/cm) Bulk solids density of approx. 1.0 to 3.0 kg/dm ³	0 to 100% vol. water content No to medium electrical conductivity (0 to 5 mS/cm) Bulk solids density of approx. 0.8 to 2.0 kg/dm ³	0 to 50% vol. water content No to low electrical conductivity (0 to 2 mS/cm) Bulk solids density of approx. 0.3 to 1.0 kg/dm ³
Probe geometry			
Round sensor, short  Temperature range: 0 to +70 °C	X	X	X
Round sensor, middle  Temperature range: 0 to +70 °C	X	X	X
Round sensor, long  Temperature range: 0 to +70 °C	X	On request!	On request!
Rod sensor  Temperature range: 0 to +70 °C	X	X	On request!
Rectangular sensor  Temperature range: 0 to +70 °C	X	X	X
Various high-temperature versions (remote electronics)  Temperature range: 0 to +120 °C	On request!	X	X

	<p>Solitrend MMP44 Precise moisture measurement in heterogeneous bulk solids with low mineral content and low to medium moisture Moisture range: 0 to 50% Conductivity range: 0 to 2 mS/cm Bulk solids density: 0.3 to 1.0 kg/dm³</p>		
	<p>Solitrend MMP44 transmitter Transmitter for measuring moisture in a continuous material flow and at hard to reach places, such as in tower dryers. Used in conjunction with round or wedge-shaped two-rod sensor. Temperature range: -10 to +70 °C Connectable to 1 x two-rod sensor (round or wedge-shaped)</p>		
	<p>Two-rod sensor (for grains, rice and other bulk solids) Two-rod sensor, round with temperature sensor with PEEK protection cap integrated in the rod (for abrasive bulk solids, optionally available with stainless steel protection cap), for connecting to the Solitrend MMP44 transmitter. Temperature range: 0 to +120 °C Conductivity range: 0 to 1 mS/cm</p>		
	<p>Two-rod coated sensor (for bulk solids with increased mineral content or steam applications) Two-rod sensor, wedge-shaped with temperature sensor with PEEK protection cap integrated in the rod, for connecting to the Solitrend MMP44 transmitter. Temperature range: 0 to +120 °C Conductivity range: 0 to 2 mS/cm</p>		
	<p>Solitrend MMP60 Precise moisture measurement in low-density bulk solids with low mineral content and low to medium moisture Moisture range: 0 to 25% vol. Depending on the product, corresponds to up to >100% dry basis moisture content Conductivity range: 0 to 1 mS/cm Bulk solids density: 0.1 to 1.0 kg/dm³</p>		
	<p>Solitrend MMP60 Large rectangular sensor for high-precision applications and for installing in vessel walls, along screw conveyors and pipes or similar Sensor surface of stainless steel (1.4301) and PEEK Temperature range: 0 to 70 °C</p>		

Accessories

Display and configuration unit



Sensor cable available in 4m/10m/25m (except in the case of rectangular sensor and two-rod sensor, fixed cable)



Universal holder with tilt mechanism



Sliding carriage incl. mounting material



Handheld instruments for accurate moisture measurement in the field

Solitrend MMP20 handheld instruments

Description

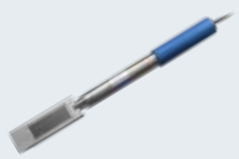
	<p>Mobile display unit Robust, battery-operated mobile display unit for various probes: Solitrend S1, S1C, S2, SWZ. Strong, weather-resistant IP67 aluminum housing. Size: 150 x 64 x 36 mm</p>
	<p>S1/S1C two-rod probe (coated rods in the case of S1C) Mobile moisture probe for sand, gravel, crushed stone and expanded clay with integrated TDR electronics. The probe has a diameter of 64 mm and uncoated rods with a rod length of 130 mm.</p>
	<p>S2 two-rod probe This particularly slim mobile moisture probe for sand, gravel and crushed stone with integrated TDR electronics enables deeper penetration of the aggregate.</p>
	<p>Telescopic extension for S2 two-rod probe Pull-out telescopic extension of up to two meters.</p>
	<p>SWZ lance probe Robust, mobile moisture probe for measuring the water content in fresh concrete. Sensor: 154 x 60 mm (length x width)</p>



All products can optionally be delivered in a robust case with inlay

Predictive sensor networking

Solitrend sensors enable easy and user-friendly sensor networking

Standard RS485 interfaces often pose significant challenges. They are not galvanically isolated and there is always the risk of ground loops or interference pulses, which can result in significant safety problems. For long cable lengths in particular, a shielded and twisted cable must be used. Depending on the wiring plan (topology), a 100 Ohm terminating resistor must be installed at sensitive locations in the RS485 network when there are individual spurs. In practice, this means significant effort for the plant operator. Up to four Solitrend sensors can be connected via the Solitrend-internal IMP bus in the case of the Solitrend version with remote display.

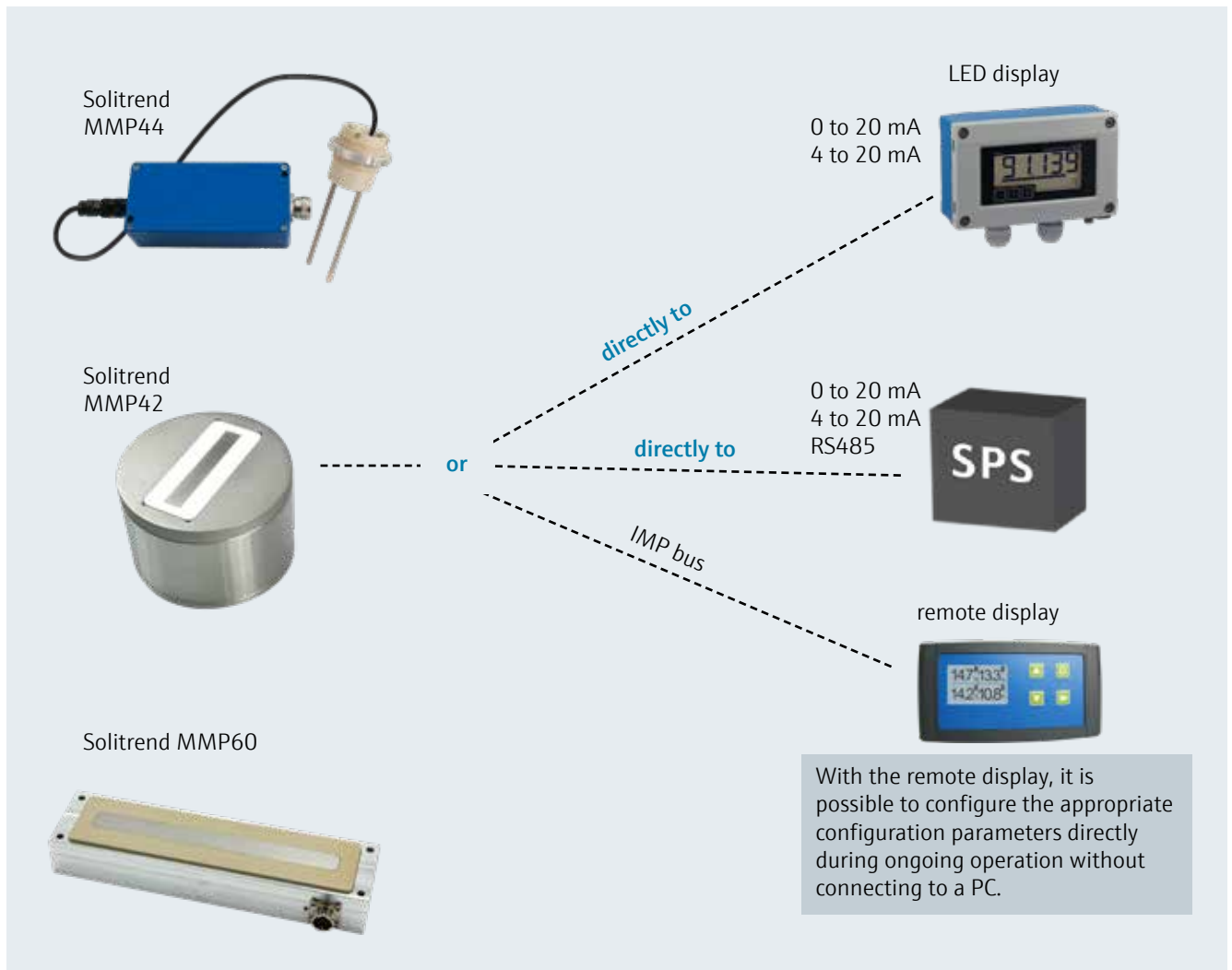

Predictive sensor networking guarantees smooth processes in your application. The IMP bus does not transmit its data packets as voltage pulses, but as current pulses. Thus, the process works even with long cable lengths on existing and already laid lines. A shielded cable is not required and even spurs in wide-ranging network topologies are not a problem.

Solitrend applications – Primaries

1

- Sand, gravel and crushed stone up to 32 mm and other aggregates can be measured easily.
- Calibrations for all conventional aggregates are preinstalled. Individual calibration based on your specific materials is possible.
- Possibility of checking the agreed maximum moisture on delivery, in real time and without the need for a laboratory.
- Minimum maintenance and maximum reliability as the TDR technology is characterized by long-term strength and stability.
- Safe handling, even under difficult environmental conditions, guaranteed by the robust and waterproof design.

2

- Sand, gravel and crushed stone up to 32 mm and other aggregates can be measured reliably.
- Calibrations for all conventional aggregates are pre-installed but it is also possible to carry out individual calibrations based on your specific materials.
- Simple commissioning with minimal calibration requirements.
- Minimum maintenance and maximum reliability as the TDR technology is characterized by long-term robustness and stability.
- Wear does not require recalibration.
- Optional replaceable sensor head for cost-efficiency.
- Easy configuration and calibration possible with remote display.

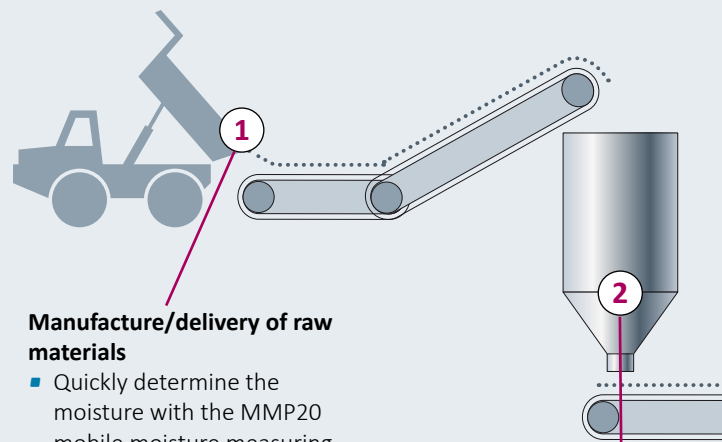

Manufacture/delivery of raw materials

- Quickly determine the moisture with the MMP20 mobile moisture measuring device with two-rod probe

Processing raw materials to make concrete

- On-line moisture measurement at or in the silo with the MMP40/MMP41 moisture sensor, short/middle round sensor or rod sensor
- On-line moisture measurement in the mixer with the MMP40 moisture sensor, long round sensor

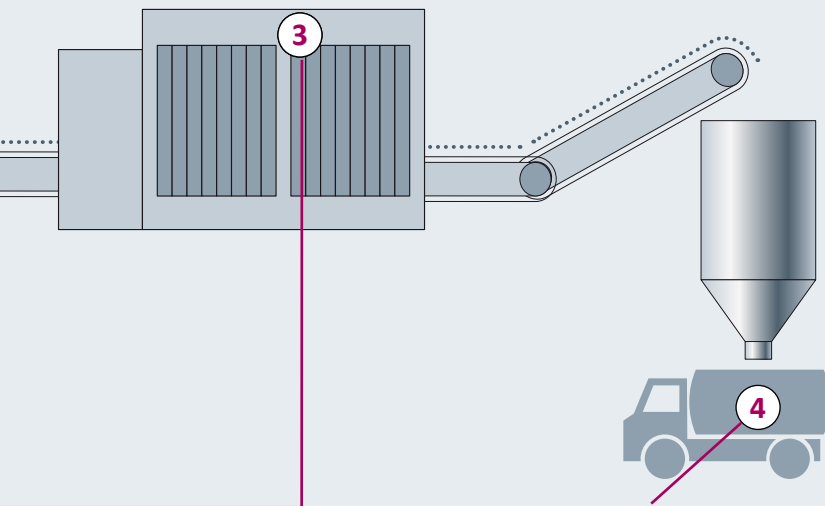

Fresh concrete quality control guaranteed by manufacturer or customer

- Quickly determine the moisture with the MMP20 mobile moisture measuring device with SWZ lance probe

3

- All conventional concretes, whether earth-moist or flowable, can be reliably measured.
- Suitable for all mixer types, e.g. turbine, counterflow, intensive or twin shaft mixers.
- Simple commissioning, minimum maintenance and maximum reliability thanks to TDR technology.
- Wear does not require recalibration.
- Optional replaceable sensor head (cost-efficient).
- Easy configuration and calibration possible with remote display.

4

- All conventional and flowable concretes can be reliably checked for water content.
- Simple measurement in the shortest time, without laboratory equipment.
- The measured value is available before the truck mixer has even unloaded.
- Simple handling, minimum maintenance and maximum reliability thanks to TDR technology.
- Wear does not require recalibration.

Solitrend MMP44 grain drying application example

The use of the Solitrend MMP44 enables:

- Direct moisture measurement in the material, even at hard to reach places
- Continuous recording and monitoring of moisture content and temperature
- Improved and more accurate process control during all steps
- Improved process stability and thus lower product losses (overdrying/underdrying)
- Cost savings due to improved energy efficiency (due to less overdrying)

Installation example for a continuous dryer

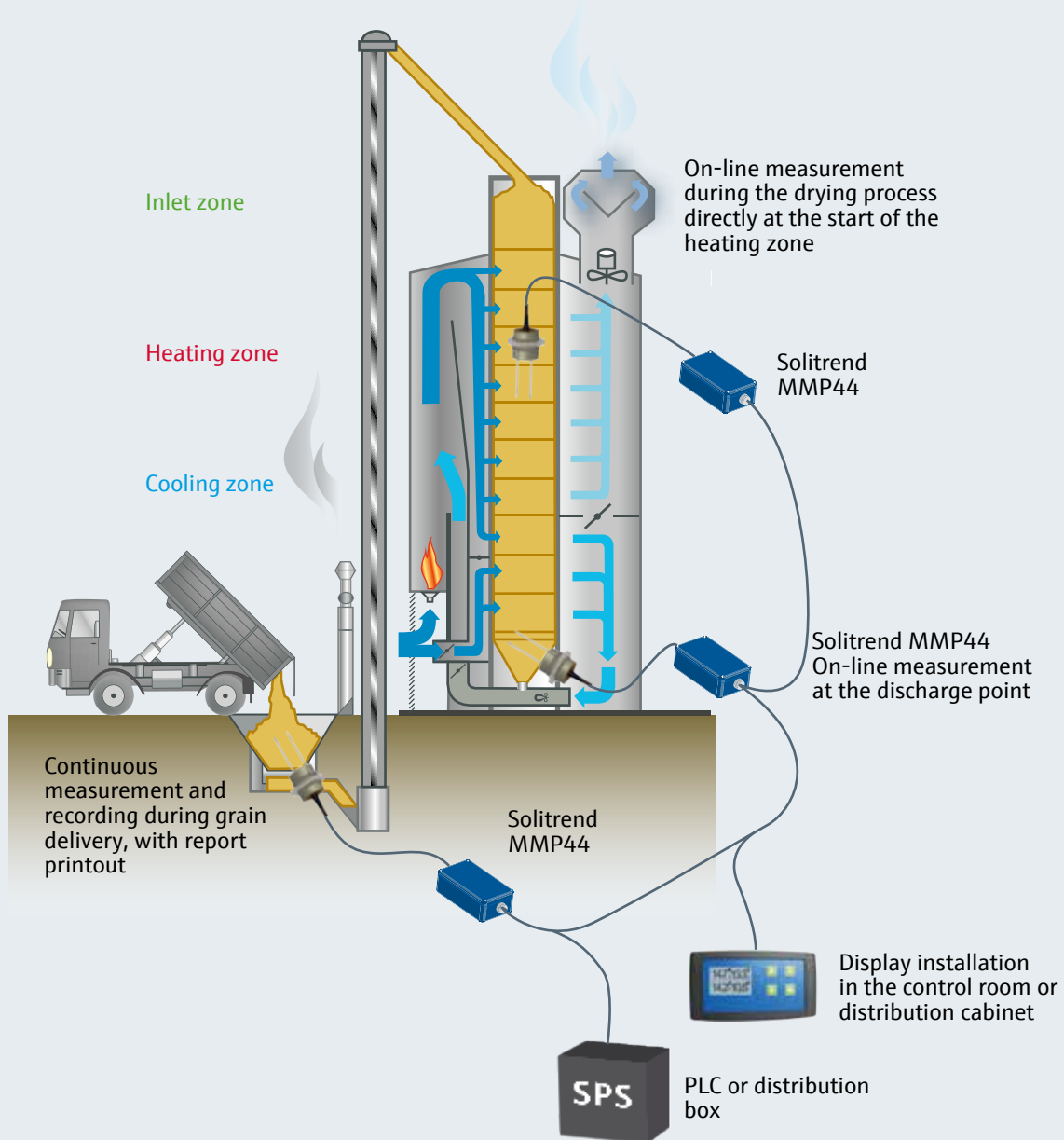

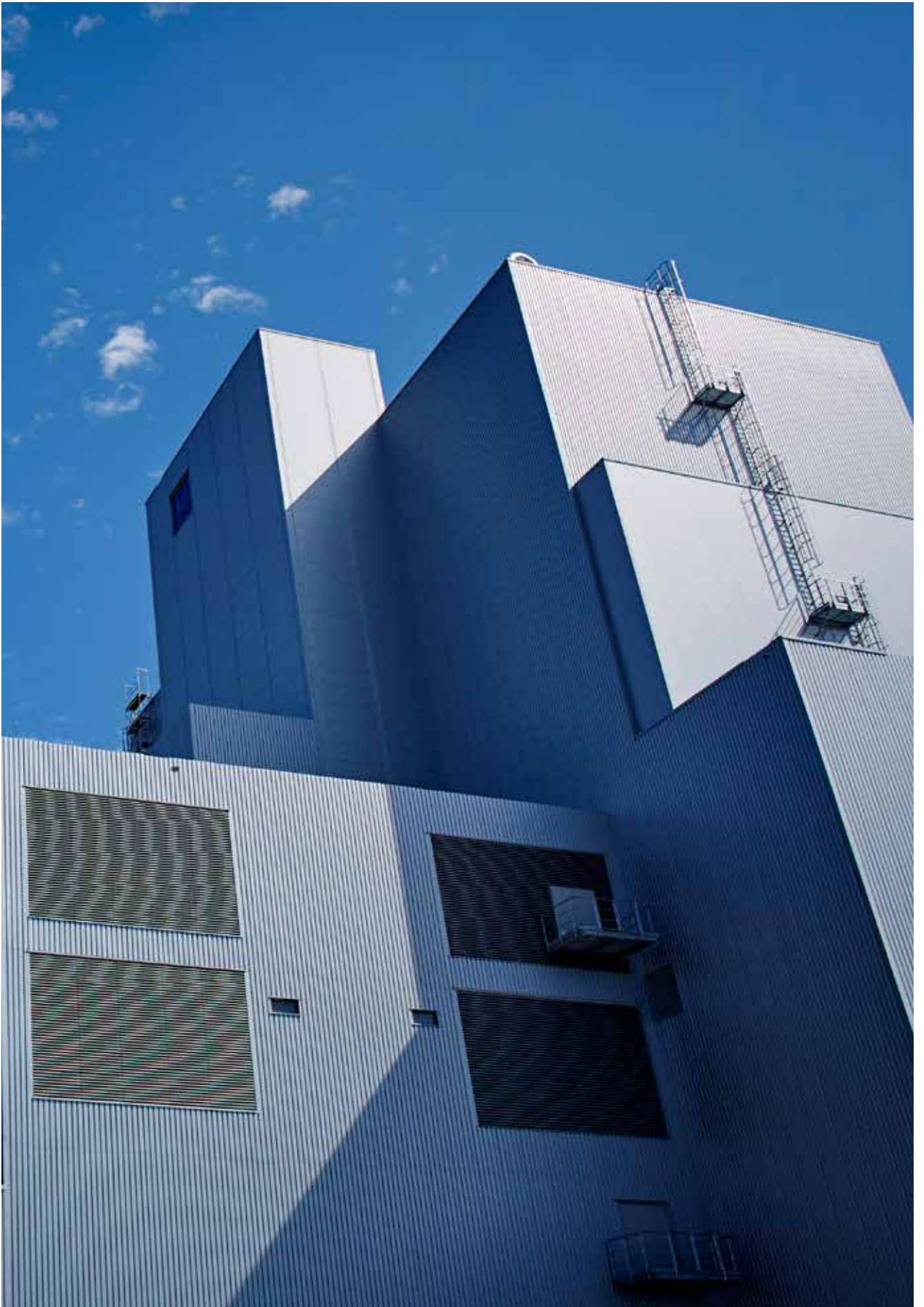

MMP60 application example in wood shavings and wood chips/wood pellets

The use of the Solitrend MMP60 enables:

- Direct moisture measurement in the material, even at hard to reach places
- Continuous recording and monitoring of moisture content and temperature
- Improved and more accurate process control during all work processes
- Increased process stability and thus lower scrap rates
- Cost savings due to increased energy efficiency (due to less overdrying)

Drying bulk solids in belt dryers

When drying bulk solids with belt dryers, an air-permeable belt is filled with the product to be dried. The height of the bulk solids on the belt and the dwell time in the dryer are defined based on the product type and properties, and the water volume to be removed. By adjusting the dwell time to the average value, it is possible to compensate for a varying moisture content. This is necessary in the production of wood pellets, for example, because the quality is no longer guaranteed if the material is excessively dry, and there is an increased risk of downtime if the material is too moist if the press closes.

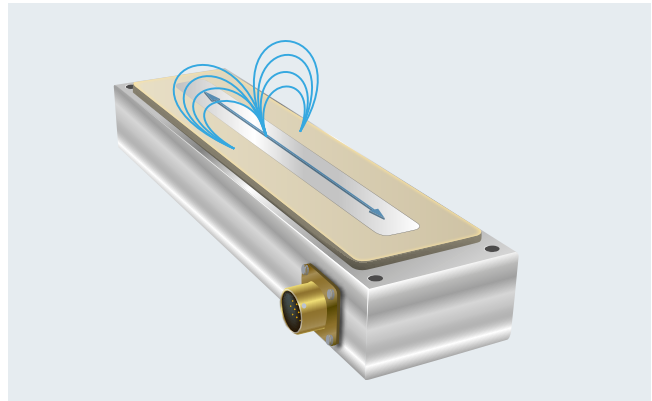

Overdrying or underdrying costs financial resources

In the past, belt dryers were often controlled manually, or by means of laborious offline sampling. This is not only time-consuming, but also results in a significant lack of process precision as it is not possible to compensate for any inhomogeneity. In addition, the sampling is implemented as a snapshot, which can result in significant inaccuracies in practice if, for example, a sample is drawn from a non-representative state (wet-pocket). Due to a lack of alternatives, a wide range of control versions have been developed over the years, either based on thermal balance or air humidity, but these methods are all indirect and depend both on the local climate and on the current weather.



Solitrend MMP60 - monitors the water content and optimizes your process control.

Using the Solitrend MMP60 sensor, you can measure the product moisture directly in the material flow and the measurement is perfect in order to determine the input moisture in the inlet to the dryer or the final moisture content at the dryer discharge point. Measuring in the dryer or on the belt is not recommended as the material does not dry homogeneously during the drying process and this inhomogeneity varies over the dwell time thus distorting the measurement. Therefore, the measurement should be taken at the discharge point, after mixing the product, e.g. at the end of the discharge screw.





Installation of the Solitrend MMP60 in a screw conveyor

If the Solitrend MMP60 sensor is installed along the screw conveyor at the discharge point, it is recommended to maintain an installation angle of 30° (see diagram) in the direction of rotation of the screw as this is where the optimal material flow is found. As an option, part of the conveyor screw can be cut out so that a backlog forms, which can also compensate for an uneven material flow.

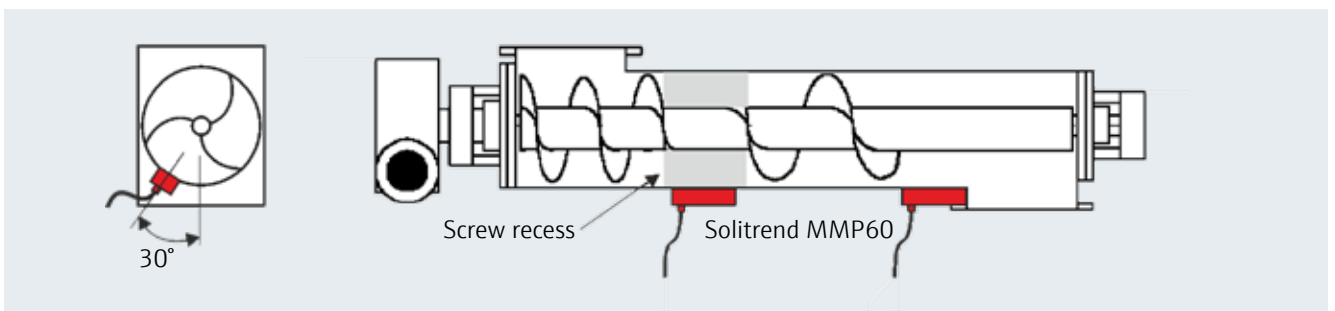

www.addresses.endress.com

CP01394M/00/EN/01.19